

Рис. 2

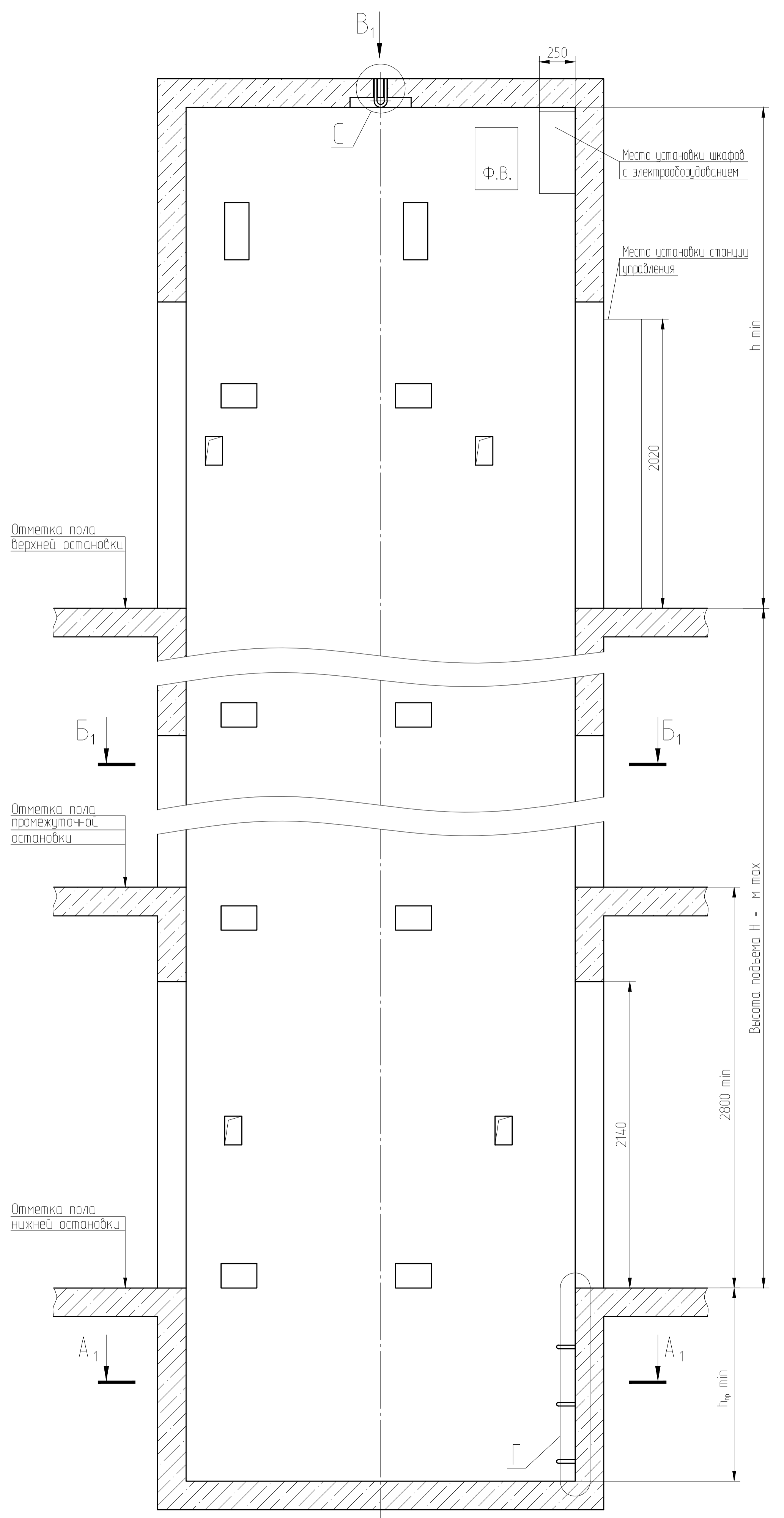

А<sub>1</sub>-А<sub>1</sub>  
Рис. 1.1

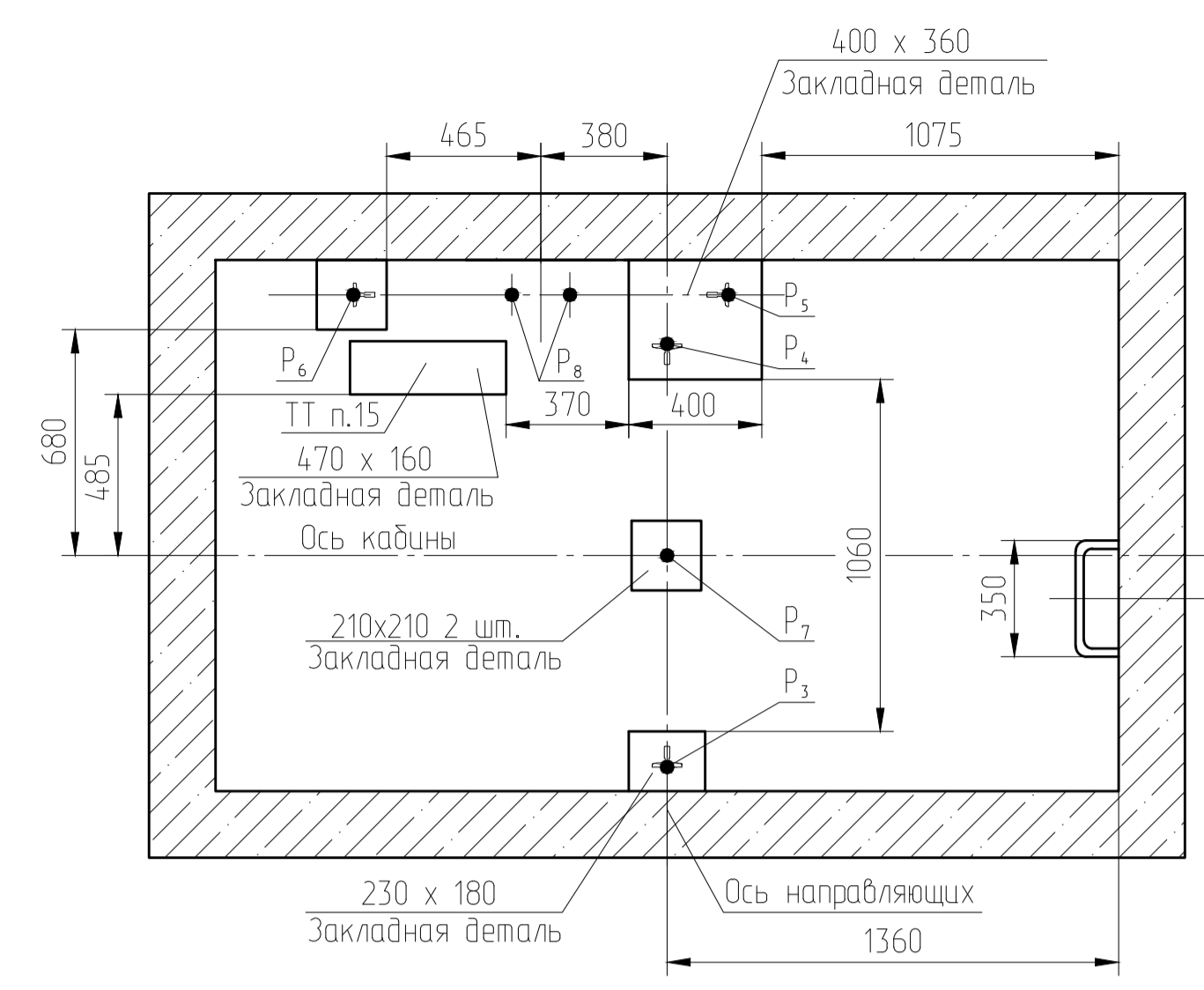

Б<sub>1</sub>-Б<sub>1</sub>



Рис. 1.2



С

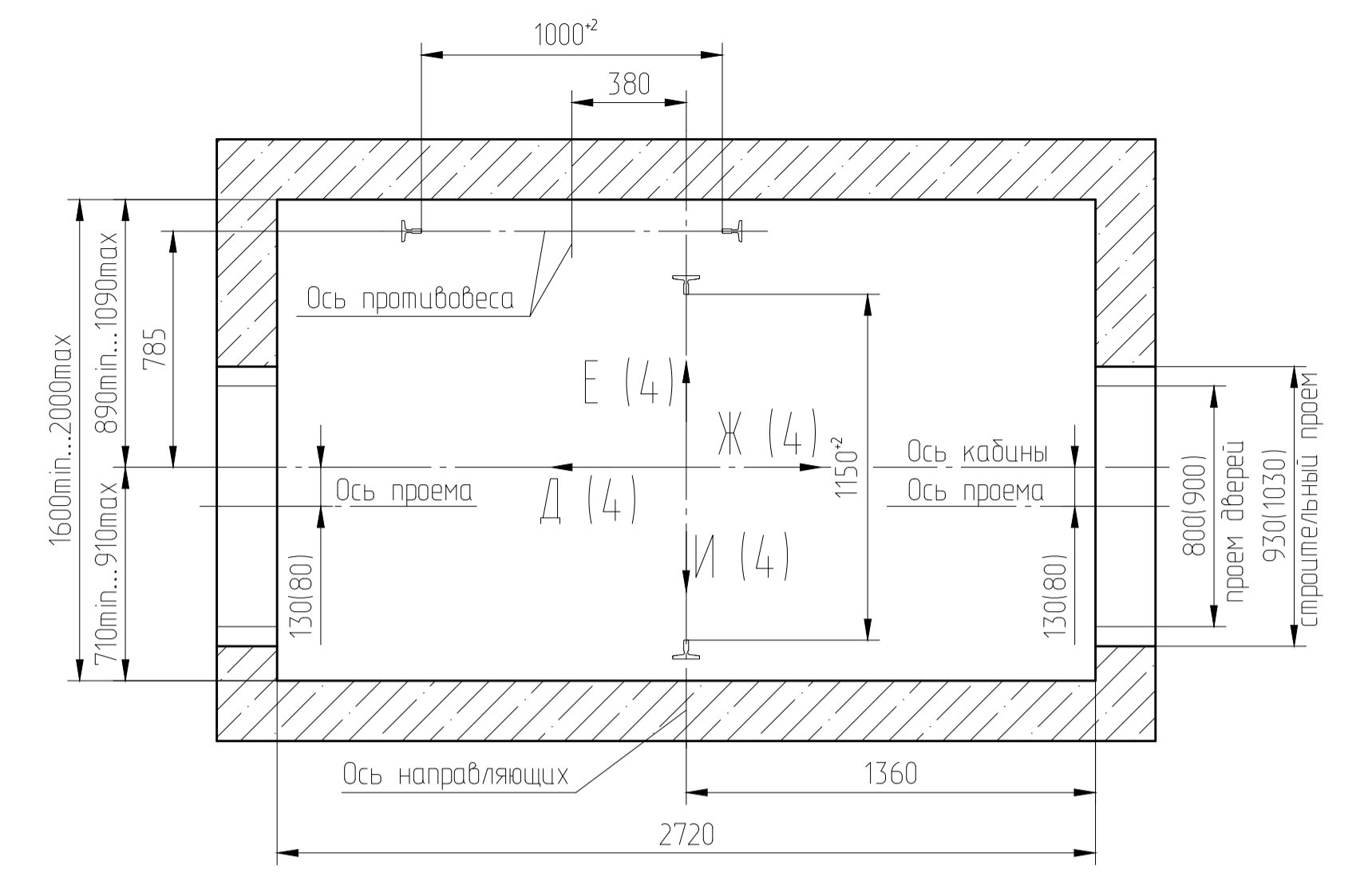
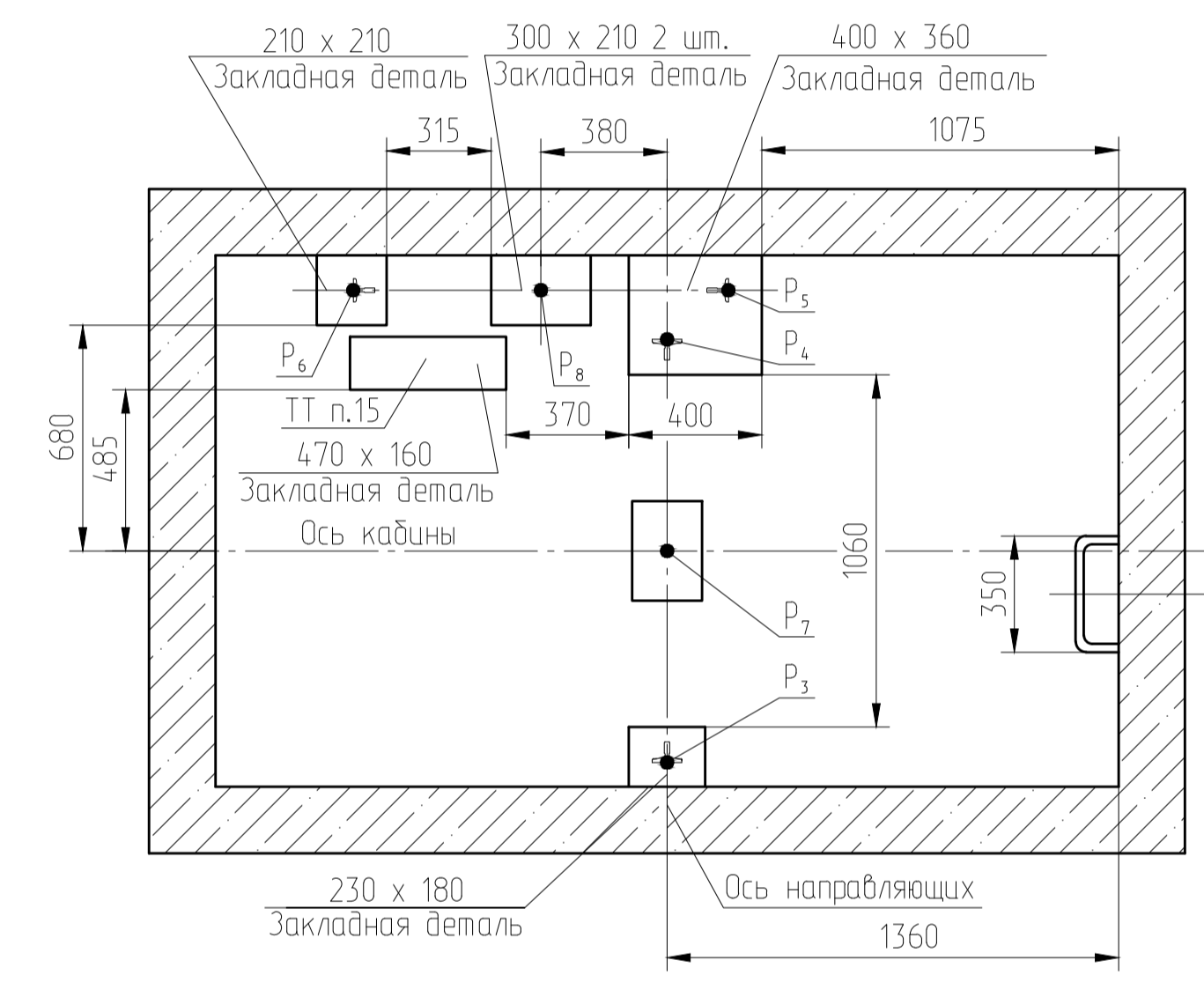
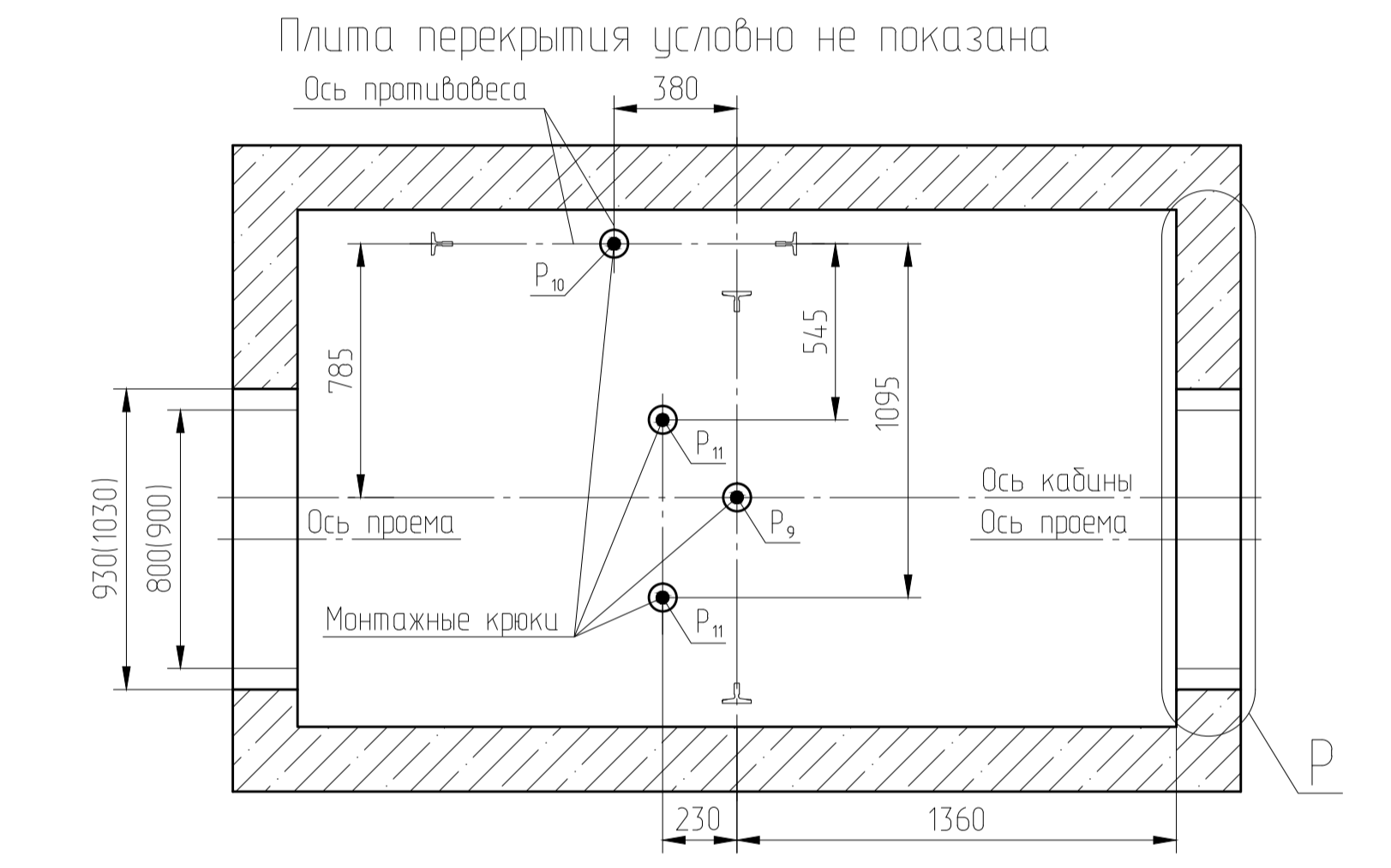

П (1:10) (2,4)

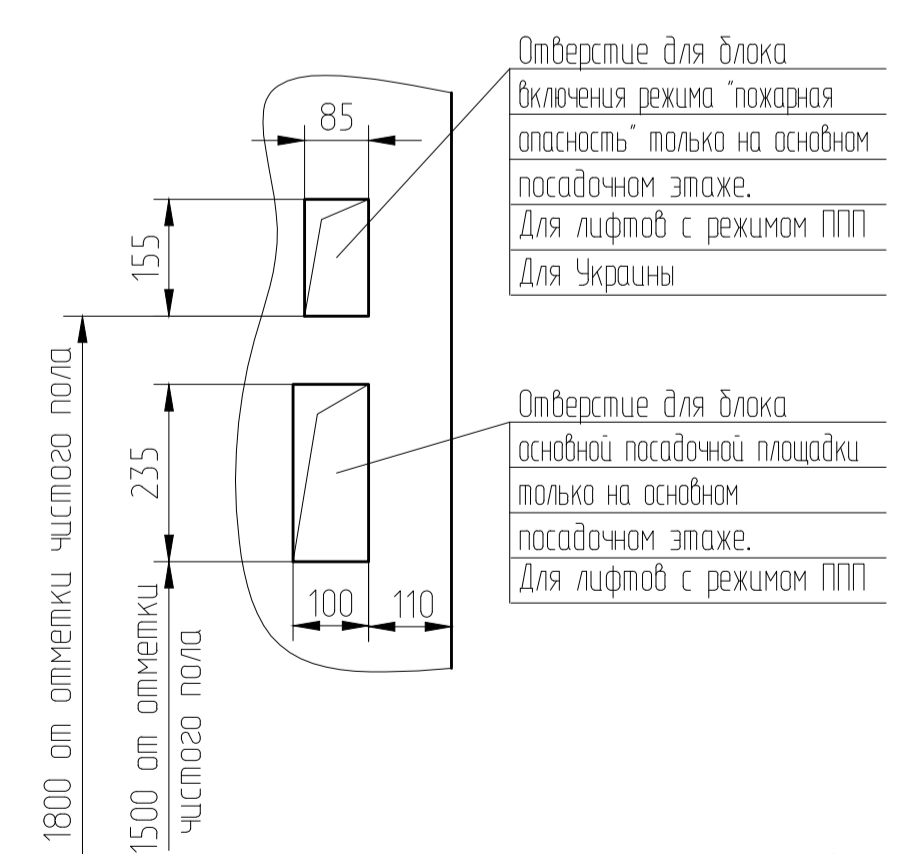

Р (1, 3)

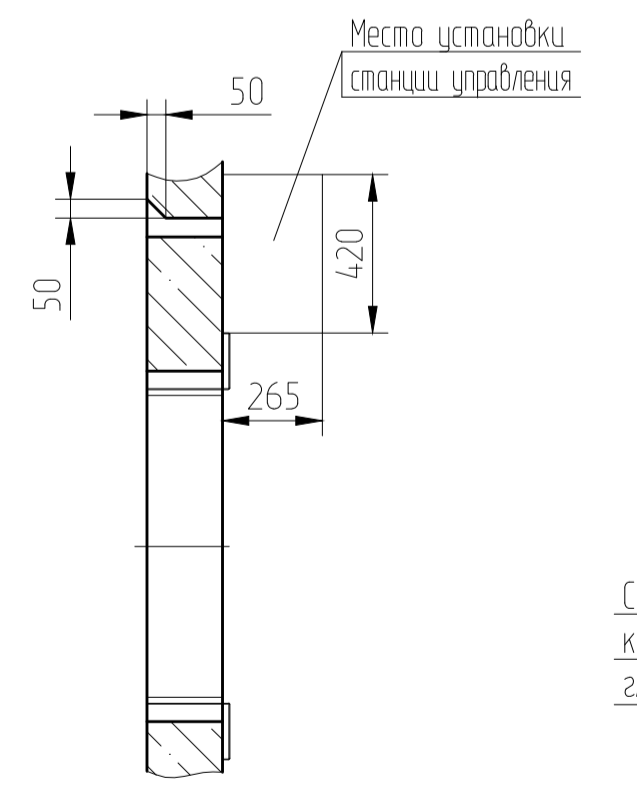

Г (1, 3)

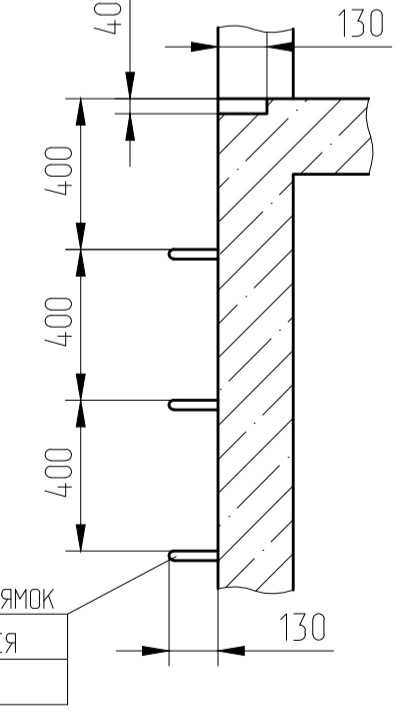

К-К (1:5) (2,4)

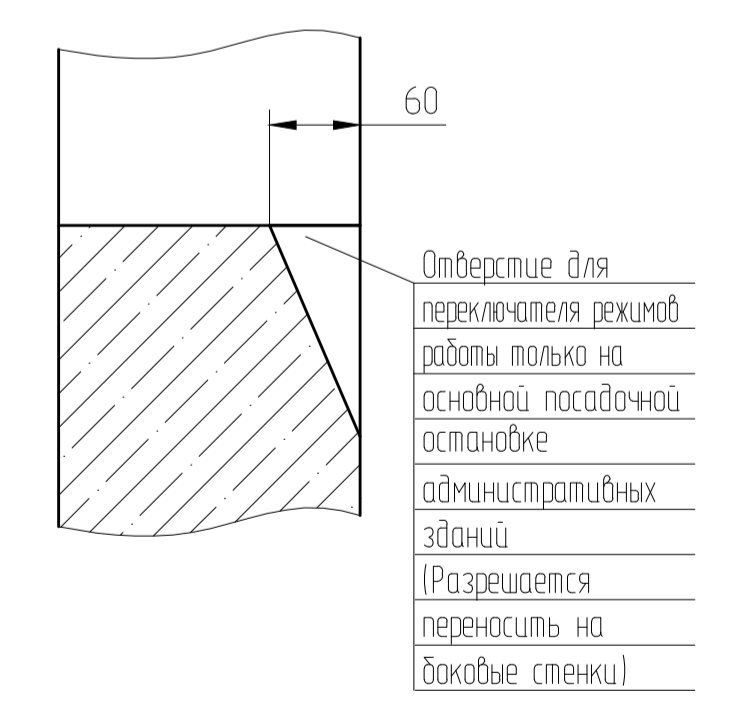

Л-Л (1:10) (2, 4)

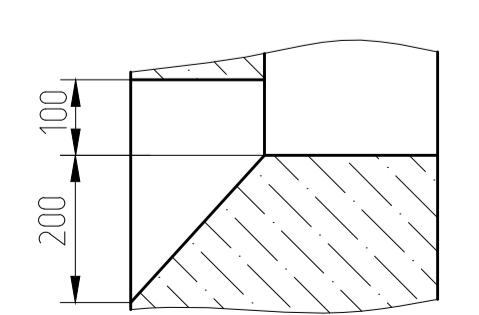

С (1:5) (1,3)

